

<b>1</b>	<b>Application area and purpose .....</b>	<b>3</b>
1.1	Contact .....	3
1.2	List of abbreviations .....	4
1.3	CATIA V5.....	4
<b>2</b>	<b>Naming conventions .....</b>	<b>5</b>
2.1	Explanation .....	5
2.2	Generating V5 data .....	6
<b>3</b>	<b>Format of products .....</b>	<b>7</b>
3.1	Product structure .....	8
3.2	Assembly constraints .....	9
3.3	Assembly features .....	9
3.4	Color coding in products .....	10
<b>4</b>	<b>Skeleton structure .....</b>	<b>11</b>
4.1	General information.....	11
4.2	Product structure and information transfer according to the skeleton ...	11
4.3	Structure of skeleton part .....	12
<b>5</b>	<b>Structure of the parts .....</b>	<b>13</b>
5.1	Naming the axis systems and body .....	13
5.2	Color coding in axis systems .....	13
5.3	Publications .....	14
5.4	Sketcher .....	14
5.5	Color coding in the part design.....	15
5.6	Body.....	15
5.7	Boolean operations .....	16
5.8	Material.....	16
5.9	General points on the design of production parts in the PartDesign.....	16
<b>6</b>	<b>Mirroring .....</b>	<b>17</b>
<b>7</b>	<b>Handling problematic geometry/measurement plans (ASM assemblies)..</b>	<b>18</b>
<b>8</b>	<b>Welded structures .....</b>	<b>19</b>
<b>9</b>	<b>Showing different positions .....</b>	<b>20</b>
<b>10</b>	<b>aCGR Application .....</b>	<b>20</b>
<b>11</b>	<b>Producing drawings .....</b>	<b>21</b>
<b>12</b>	<b>BA catalogs .....</b>	<b>23</b>
12.1	Standard catalog .....	23
12.2	Material catalog .....	24
<b>13</b>	<b>Handling standard and bought-in parts (internally) .....</b>	<b>24</b>
13.1	Standard parts .....	24
13.2	Bought-in parts .....	24
<b>14</b>	<b>Data quality .....</b>	<b>25</b>
<b>15</b>	<b>External offices .....</b>	<b>26</b>

**Change history:**

13	Approval module revised	Otholt, S.	11/18/2014
12	Release module changed and information text added	Otholt, S.	10/8/2014
11	Completely revised	SK	9/28/2014
10	Change of company logo	Baumann	8/9/2012
09	2.1, 2.2 modified, 9.6, 9.10 not applicable	MH	11/25/2011
08	5.3 / 5.5 / 5.9 / 7 extended/abridged, 9.11 no longer in use	MH / SK	9/28/2011
07	4.4 / 5.1 / 5.3 / 7 / 9.15 / 11 / 13 changed/addition	SK / MH	2/16/2011
06	Completely revised	SK / MH	10/1/2010
05	Completely revised	MH / Nol	2/10/2010
04	Completely revision/abridgment	MH / Nol	12/7/2009
03	3.2 / 4.2 / 6.1 - changed	Nol	11/24/2009
02	2.1 / 3.12 - changed	Nol	10/19/2009
01	Archive in document management	Nol	4/14/2009
<b>Index</b>	<b>Description</b>	<b>Name</b>	<b>Date</b>

**Released:**

The authoritative and approved version of this company standard is only available on the Broetje-Automation intranet. Hardcopies and locally stored copies must be verified as they are not subject to change management. The website of Broetje-Automation “[www.broetje-automation.de](http://www.broetje-automation.de)” serves as an alternative source of company standards for external parties.

## **1 Application area and purpose**

This guideline describes the specifications and methods for generating CAD data using CATIA V5. It is binding as a procedural instruction as part of

### **DIN EN 9100 certification**

for all members of staff within the design department at BA and BAS, and for contractors who undertake design work for these firms.

The general (CAD independent) specifications for producing and processing design documents can be taken from the “*BN10.010 Design Specification*”.

Any deviations from the specification have to be agreed and documented with the project manager and the CAD department. This applies particularly to projects where an external specification has to be observed as a priority.

Further information can be found on the [BA intranet](#).

BN10.010 Design Specification  
BN10.035 Hard-and Software Requirements  
BN10.012 Sample Drawings  
BN10.050 Welding Instruction Design  
BN10.060 Principles for Steel Construction  
CAD Handout – Asm Assembly  
CAD Handout – Development of Welded Assemblies  
CAD Handout – DMU Assemblies  
CAD Handout – Use of aCGR  
Installing Catia V5R18 with Airbus package and in a Broetje environment

### **1.1 Contact**

Tel.: +49 4402 966460  
e-mail: [cad@broetje-automation.de](mailto:cad@broetje-automation.de)

## **1.2 List of abbreviations**

BA	Broetje Automation GmbH
BAW	Broetje Automation Wiefelstede site
BAS	BA Services GmbH Jaderberg site
AMS	Order management system (BA's internal ERP system)
EDM	Engineering Data Management
CDB	EDM System CIM DATABASE
WSM	Workspace Manager (part of the EDM system)
Env	Environment (components)
HF	Hot Fix
SP	Service Pack
Sk	Skeleton (part)
ASM	Assembly
SWT	Welded part
DMU	Digital Mockup (memory-saving storage space)
GSM	Generative SheetMetalDesign (Catia Workbench)
TCE	Team Cad Edm
B-Rep	B-Rep elements are all those that are not available in the structural tree (e.g. body edges, part surfaces of solids, etc.)

## **1.3 CATIA V5**

The **Broetje V5 environment** is to be used in all orders, if there are no project-specific specifications (e.g. AIRBUS environment). Only the English interface is permitted.

The current installation package is available on the Broetje FTP server.  
Access can be provided upon request.

The given configuration can be taken from the factory standard "BN10.035 Hardware and Software Requirement" and should be requested in the TCE department.

See Section 1.1 for contacts

## 2 Naming conventions

### 2.1 Explanation

An 11-digit drawing number is specified for each assembly (example: 000.345.215). The drawing number is unique for all projects. The drawing numbers of the individual parts can be derived from the drawing numbers of the assemblies. The drawing number corresponds to and forms part of the CATIA V5 file name and CATIA V5 part number.

The use of special characters and umlauts is not permitted in the part number and the file name.

Example: drawing number of the assembly = 000.345.215

Document Type	Name File Name	Part Number
3D assembly	000.345.215.CATProduct	000.345.215
2D assembly	000.345.215-x.CATDrawing (x = page format 0-3)	not applicable
ENV components (ENV – see chapter 3)	not applicable (No separate file)	000.345.215_env
Skeleton part	000.345.215_skt.CATPart	000.345.215_skt
3D individual manufactured part	345.215.xxx.CATPart (xxx = counter 101-199, start at 101)	345.215.xxx
2D individual manufactured part	345.215.xxx.CATDrawing (y = page format 0-3)	Not applicable
CGR files	000.345.215_cgr.cgr	000.345.215_cgr
Automatic CGR files	000.345.215_acgr.cgr (generated automatically by the PDM system)	000.345.215_acgr

## 2.2 Generating V5 data

### 2.2.1 Properties of products and parts

The specified naming rules must be adhered to when generating new components, single parts (see also BN10.010 – Design Specification).



The BA-V5 standard tool is a tool that checks the rules when an entry is made or reliably converts it. It helps the user to produce new records or amend existing ones. It forms part of the specifications and has to be used when generating and amending all design documentation.

### 2.2.2 Automating data generation using the BA-V5 standard tool

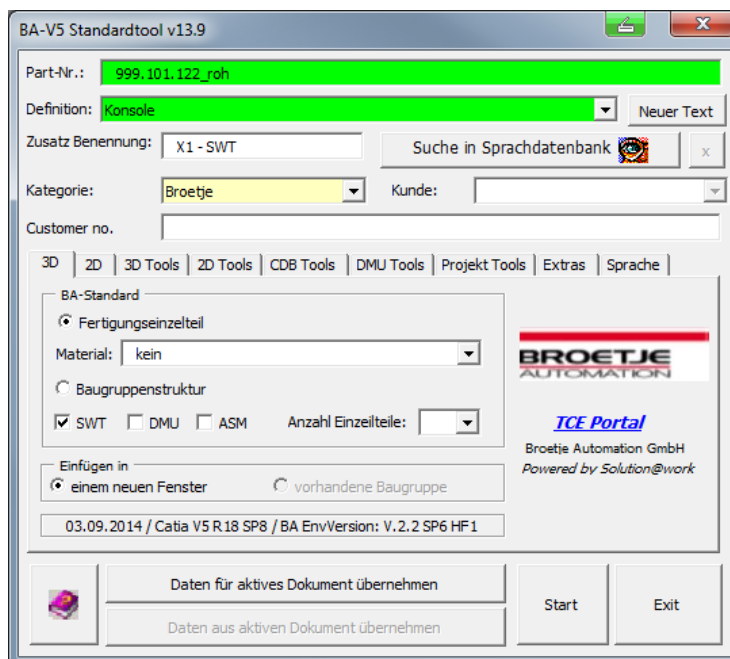
The macro is accessed in CATIA using the icon .





(Fig. version Sept. 2014)

An instruction sheet/help is linked several times in the standard tool and can be accessed using the relevant icon (, )

### 3 Format of products

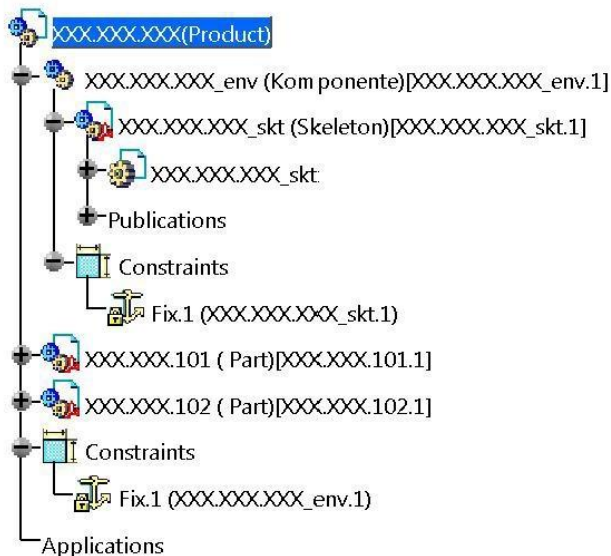
The product structure of a project is stipulated by BA.



For better structuring and to achieve better handling, components may be used when producing manufacturing assemblies (). The assembly structure set out in AMS must be adhered to.

The added components () may not reflect the kinematic circumstances of the assembly. That means it must be/remain possible to simulate the model. Copies of components from other assemblies can only be added with the command “Paste Special – Break Link.”

A sensible use of components is, for example, bringing together of parts of a screw fitting (screw, shims, and nuts). The screw components may then be positioned several times within the assembly.

### 3.1 Product structure

Every assembly has a component (ENV component). All data (skeleton part, workpiece data, controlling geometry, interfering contour), which are required to model the assembly, are added in this component.

- This component has the zero point rivet of the assembly and may not be moved
- This component is fixed into place

Every assembly has a zero point rivet. This zero point rivet is represented by the master axis system of the skeleton part.

- The skeleton has the zero point rivet of the assembly and may not be moved
- The skeleton part is fixed into place

These specifications are implemented automatically by using the BA standard tool.

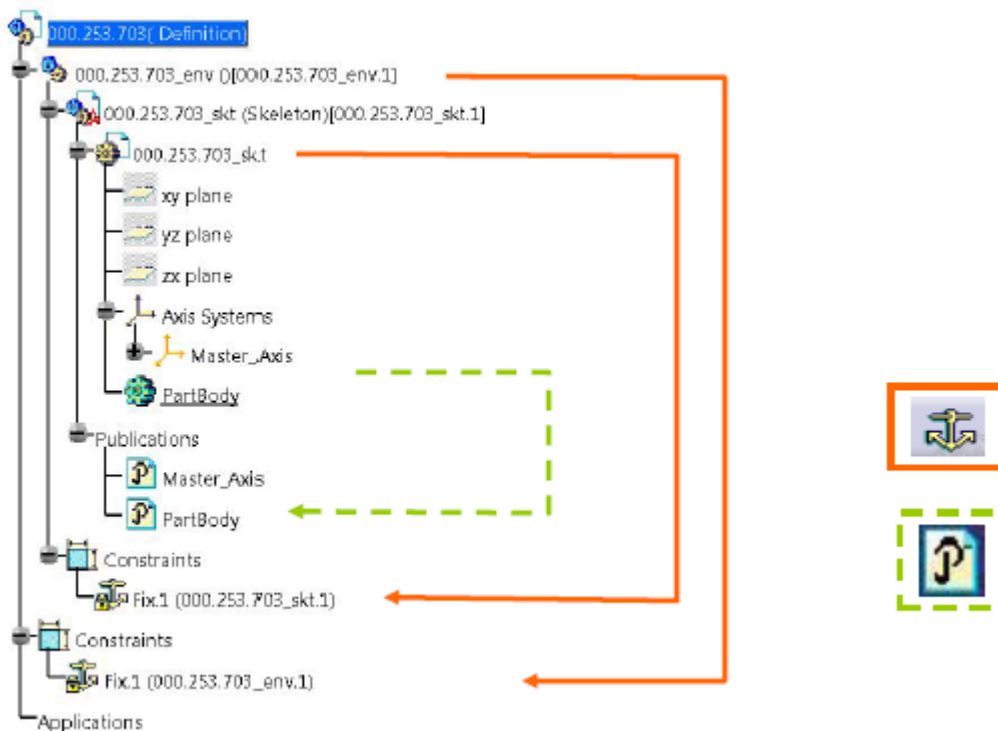



### 3.2 Assembly constraints

The permitted constraints are as follows:

- *Coincidence*
- *Contact*
- *Offset*
- *Angle*

Exceptions: The constraint **fixed** is permitted when deciding components, skeleton, and workpieces (customer data).

Constraints may only be generated between published elements (see Section 5.3). The elements to be published should preferably be selectable features in the structural tree (point, line, plane, body etc.), no partial surfaces etc.

All parts of the components may only have the degree of freedom that is required for their movement/function.

*Example: A screw can revolve completely around its axis.*

Manufactured parts may not be possible using standard and bought-in parts. This facilitates the subsequent replacement of standard and bought-in parts.

*Example: Screw connection between two sheets. First link the sheets to be screwed with constraints, then the screw with one of the external sheets.*

### 3.3 Assembly features

The use of assembly features is **not permitted**.



The process for mirroring is explained in *Section 6*.

### 3.4 Color coding in products

Following color coding is prescribed for better clarity:

Item	Color	RGB Values
Steelwork	Gray	210-210-255
E-components	Yellow	255-255-000
Flaps, moving parts	Orange	255-095-000
Rails	Light blue	131-170-214
Floor coverings	Light brown	190-135-000
Energy chains	Black	000-000-000
Media supply	Purple	255-000-255

Coloring takes place on the relevant workpiece entity within the assembly.

Saving a transparent image is **prohibited**.

Use of the color “red” is **prohibited**, as red indicates an update in the CATIA standard.  
(Exception: layouts/hall layouts to satisfy customer requirements)

## 4 Skeleton structure

A uniform skeleton structure is required in the product structure.

### 4.1 General information

All workpiece data and environmental geometry (manufacturing hall, adjoining machines, traffic routes etc.) have to be stored in the environment of the main assembly.

From there the necessary geometries are distributed to the subassemblies through publications.

**The scope of the information to be handed over should be kept as great as necessary and as small as possible!**

### 4.2 Product structure and information transfer according to the skeleton

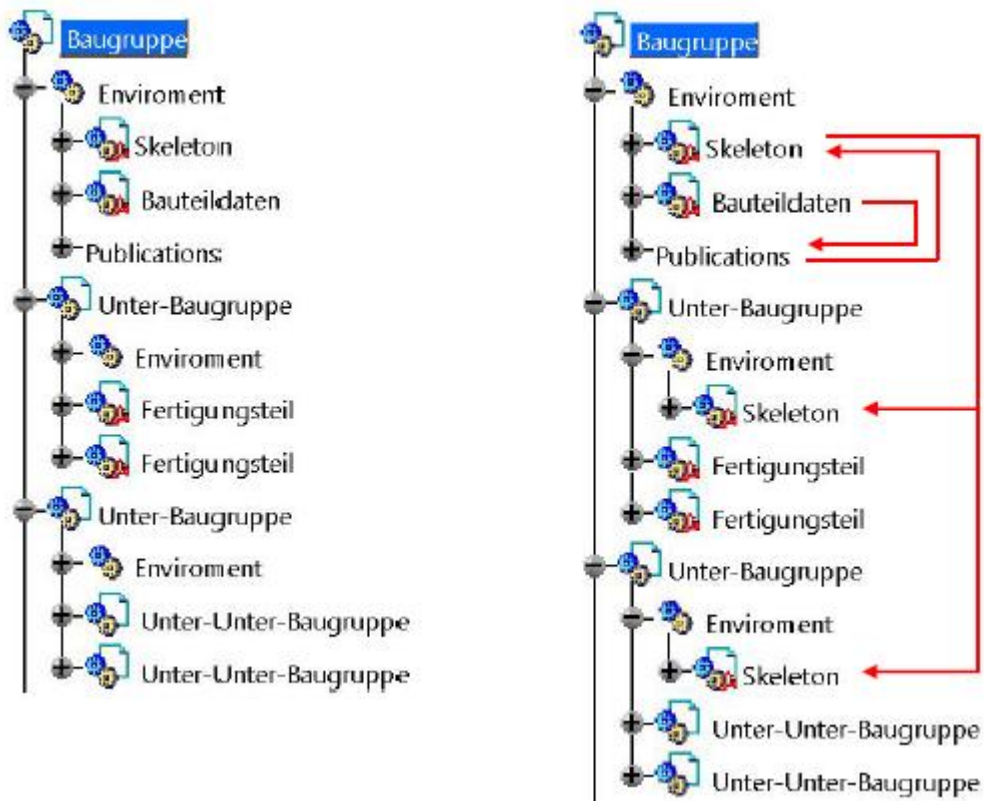

### 4.3 Structure of skeleton part

An assembly is generated automatically with a skeleton part when using the BA standard tool.

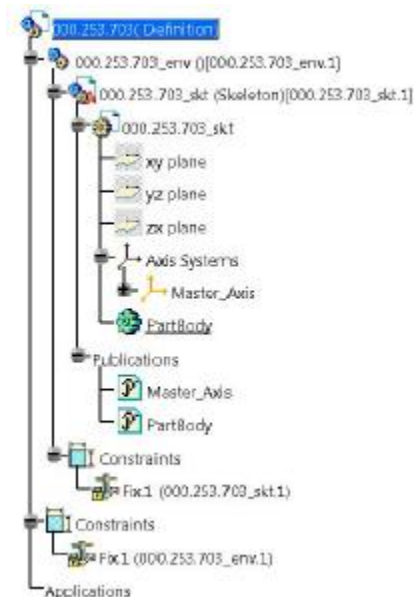

A component has to be created and fixed in each assembly at the start. Designation:

***drawing number\_env***

Referred in the following as ENV (ENV= Environment)

The skeleton part is set with the following name within the ENV:

***drawing number\_skt***

The axis system of the skeleton part lies on the zero point rivet of the assembly and is given the following name:

***Master\_Axis***

The PartBody (main body) of the skeleton part is given the following name:

***PartBody***

Both the axis system and the skeleton PartBody have to be published. This is implemented by the tool when using the BA V5 standard tool.

## 5 Structure of the parts

Hybrid bodies are not permitted.





### 5.1 Naming the axis systems and body

The main body is named PartBody. The axis system is given the following name:

Model Type	Name of the Axis System
Single part	Axis
Unfinished welded part	Axis
Standard part	Axis
Bought-in part	Axis
Skeleton	Master_Axis

### 5.2 Color coding in axis systems

Following colors, line thicknesses, and line types have to be assigned for the axis systems:

Element	Color	Line Thickness	Line Type	Comment	RGB
Master_Axis (skeleton)	 Basic32	0.35 mm	2	Axis system of the main assembly	255.255.0
Positioning axis system (skeleton)	 Basic35	0.35 mm	1	For positioning assemblies	0.255.0
Axis system part		0.13mm	1		255,255,255

### 5.3 Publications

If a feature is published, its name must be preceded by the following abbreviation:

Main body	PartBody
Axis	Axis
Axis (skeleton)	Master_Axis
Surface area	su_
Plane	pl_
Point	pt_
Line	ln_
Sketch	sk_
Parameter	pa_
Curve (or spline)	cu_



Preference is given to the use of features from the structural tree. B-rep elements, such as partial areas or edges of bodies, should not be used if at all possible (unstable).

### 5.4 Sketcher

- All sketches have to be fully defined (green).
- Sketches should be created with edges that are as sharp as possible. Chamfers and radii should be generated as features as far as possible and not saved in the sketch.
- Drill holes may only be created with the help of the  drilling command. Producing drill holes through definition in the sketch is only permitted for flame-cut or punched drill holes.
- Projections (in particular of B-rep elements) should not be used, if at all (unstable).
- Dimensioning the axis system/main levels of the part is **prohibited**. The H and V-axes (yellow) of the sketch are used for referencing.
- A sketch should only contain one contour.
- Preference is to be given to positioned sketches.

### 5.5 Color coding in the part design

The coloring may only be carried out to selected features in the structural tree.

Objects	Color	RGB Values
Steelwork	Gray	210-210-255
Tapped holes	Blue	000-000-255
Drill holes for threaded inserts	Burgundy	128-064-064
Fittings	Cyan	000-255-255
Milling and functional areas	Dark green	000-128-000
E-parts	Yellow	255-255-000
Welded finished part (CATPart)	Sandy brown	211-178-125

Saving transparent images is prohibited.

Use of the color “red” is prohibited, as red indicates an update.

### 5.6 Body

Multibody parts are not permitted.

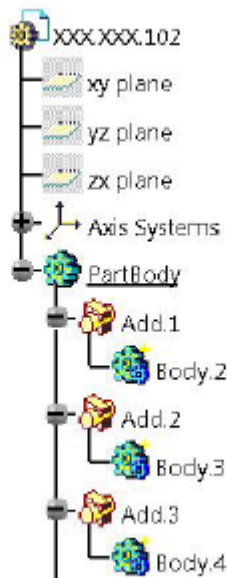
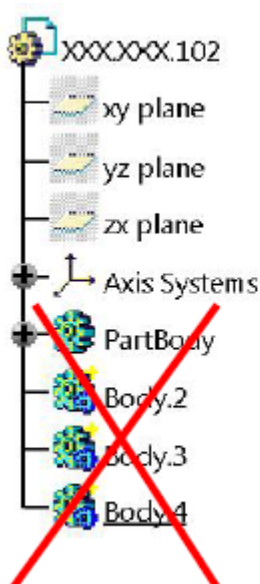

### 5.7 Boolean operations

Bodies may not be assembled using the “Assemble” operation.

### 5.8 Material

Material is to be assigned to the part (not to the body).

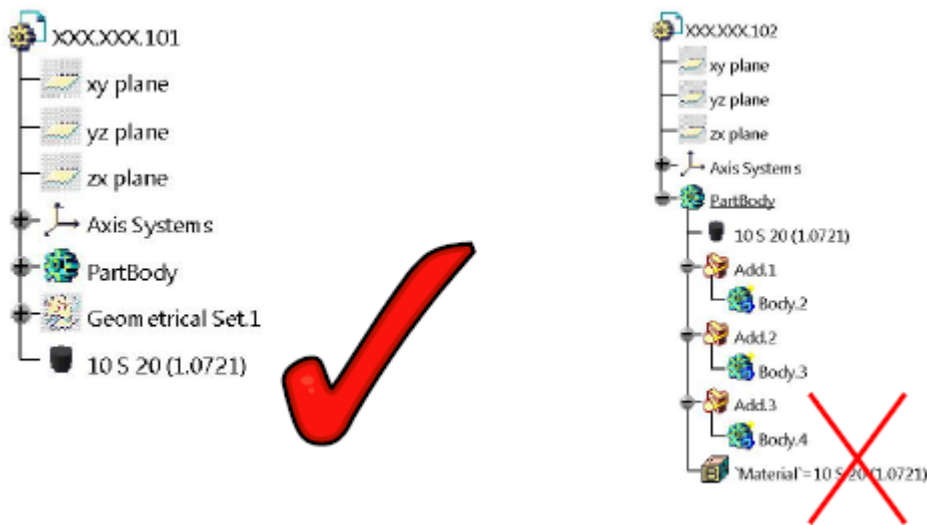

### 5.9 General points on the design of production parts in the PartDesign

- Renaming and archiving are only possible with the macros provided for these purposes.
- Links to design tables have to be removed and disabled.
- Tapped holes have to be produced with the  drilling command.
- Deactivating elements in the part (e.g. drill holes, recesses) is not allowed.
- The use of special characters and umlauts is prohibited.
- The main body must be defined in the work object (Define in Work Object) at the end of processing.



## 6 Mirroring

When producing mirrored workpieces ensure that it is really a mirror-symmetrical workpiece.

Producing drawings of mirrored workpieces of a CATPart or a reference in the “Part XY mirror image” drawing or similar is not allowed.

The following procedure is to be applied to produce or show mirrored workpieces:

- Save the part to be mirrored under a new file name and mirror the body with a “*symmetry*.”

The new part is given its *own drawing number* and *its own new drawing*.

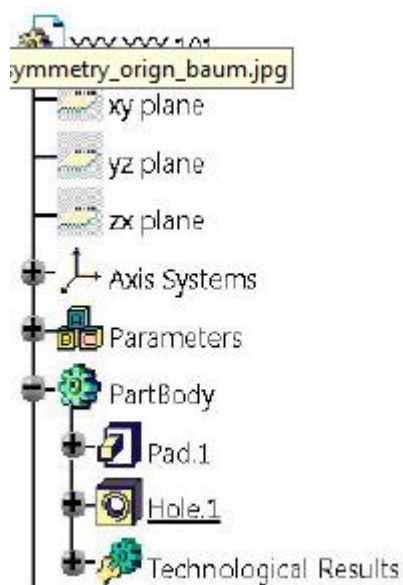

Fig.: Original

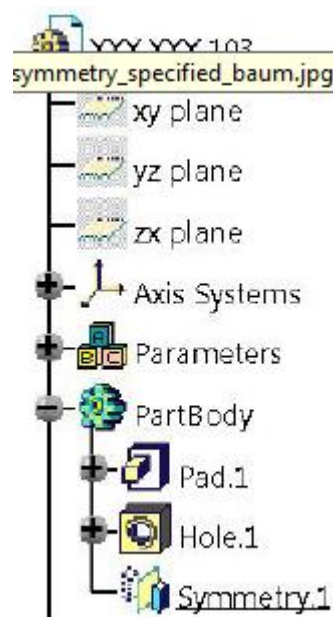

Fig.: Copy with Mirroring

## 7 Handling problematic geometry/measurement plans (ASM assemblies)

The ASM method is used, if an adjacent assembly (interfering contour) is also to be shown in an assembly drawing, or an assembly produced for creating measurement and test plans, which includes a geometry of other/adjacent assemblies for a better understanding.

To do this, a new higher-level assembly (`_asm`) is generated, in which all the necessary assemblies are loaded. This higher-level assembly is given the name as the actual assembly with the suffix "`_asm`" and is created based on the Broetje specification (BA-V5 standard tool).

No additional data is generated for the necessary assemblies (CGR, etc.). A link is made to the original assemblies or the DMU assemblies.

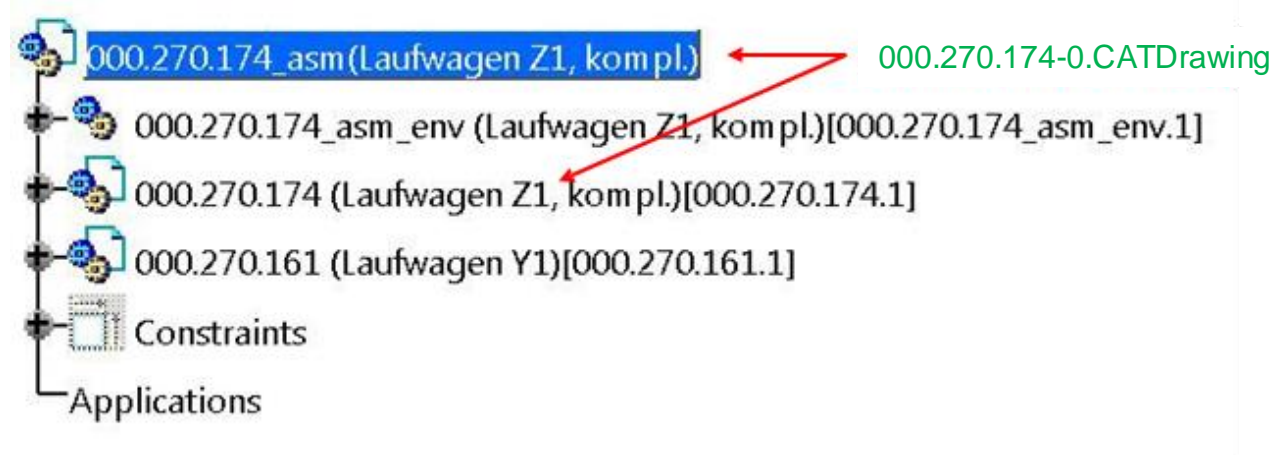

A detailed description and further information can be taken from the **CAD Handout - ASM Assemblies** and Section 10 of this document.

## 8 Welded structures

Welded assemblies are constructed in accordance with the “**CAD Handout - Structure of Welded Assemblies**” document.

All the unfinished parts of an assembly are structured in a product. The principles from the BA standard (Factory Standard BN10.050, BA CATIA V5 Material Catalog) should be included in the selection of raw materials. One further part is produced in this assembly that represents the finished part – the welded unfinished parts with the finishing operation. The individual published bodies of the unfinished parts are copied in this part with a link (*As Result with Link*), assembled (*Add...*) and then processed accordingly.

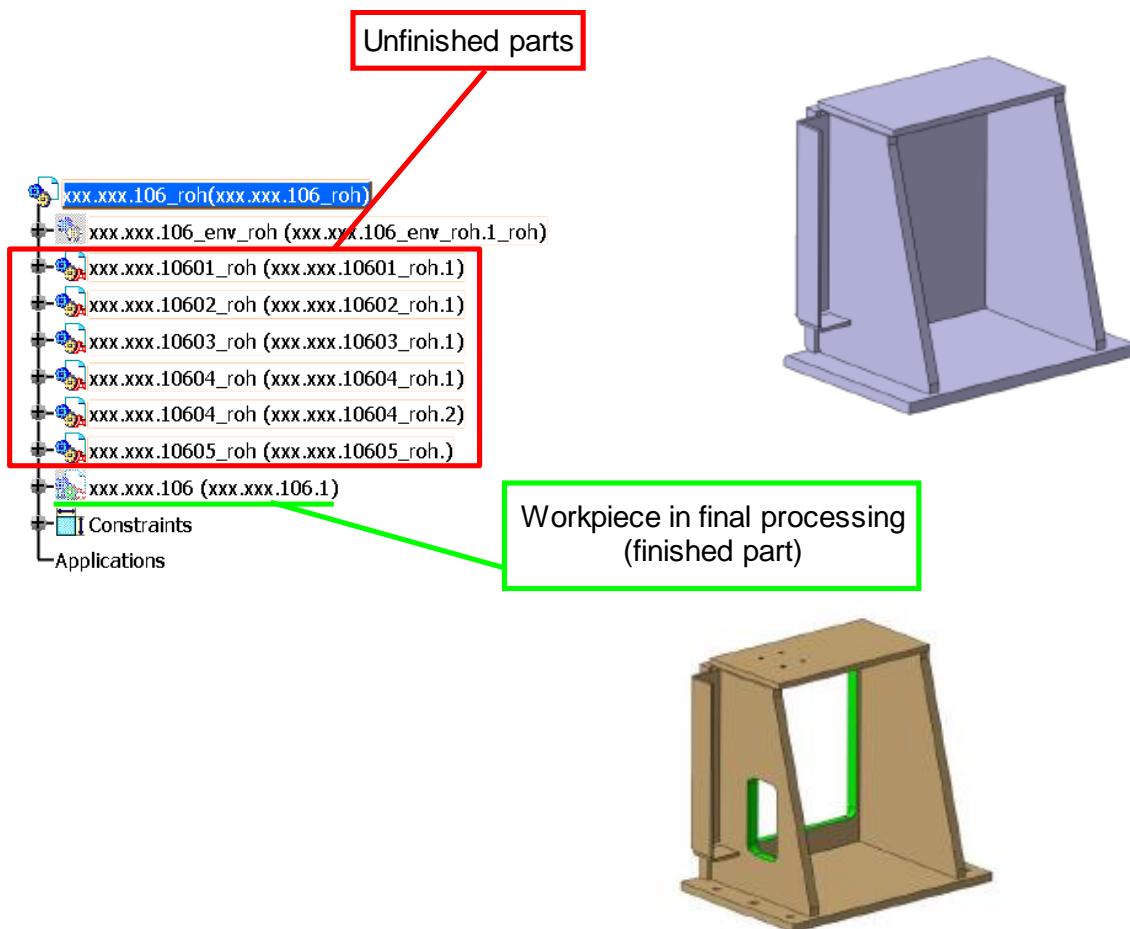

The finished part (encircled green) is the part that represents the welded parts in another assembly. Only this part will be fitted in an assembly.

## **9 Showing different positions**

It can arise with bought-in parts and assemblies that they have to be shown in different positions.

To be able to meet this objective fact, there is the option of bringing these parts into the required position and saving them as a further file.

The file name and part number (PartNumber) in this case is expanded to include an “s” and a two-digit sequential counter (starting with 01). This appears as follows:

XXX.XXX.XXX\_s01.CATPart

This process can be used for assemblies and bought-in parts. These parts are assigned to the same item and have to represent the same part only in another position.

## **10 aCGR Application**

Large assemblies (high number of parts and subassemblies) entail two performance problems.

- Long check-in and checkout times (CDB transfer) because of the high number of files
- Lengthly loading times in CATIA V5 because of the high number of files

To do this, aCGR files are produced by the subassemblies of a main assembly by the CDB and the main assemblies are comprised of these.

The detailed procedure is described in the “*CAD Handout – aCGR Application*” and “*CAD Handout – DMU Assemblies*” documents.

External offices are unable to work with this method, as they do not have the required access to the PDM/EDM system (CDB) from Broetje.

## 11 Producing drawings

Information on producing drawings can be found in “*BA\_Design Specification BN10.010.*”

- 1) All language-dependent text can be taken from the language database. They are taken using the language tool and should be used to generate texts in a drawing. Only combinations of texts, such as tables, can be taken from the BA catalog. The standard texts are to be placed in a work view. Care should be taken when inserting standard text that each drawing sheet is active, i.e. the text may not be added in a derived view.

If 2D components are inserted into the drawing from a catalog, all the existing links between the 2D components and their reference should be removed with “*Explode 2D Component!*”

- 2) Only the Broetje drawing frame should be used to generate drawings (call up using the BA V5 standard tool).
- 3) All parts for 2D derivation the must be shown in such a way that the geometry is clearly recognizable.
- 4) Showing different geometric forms of a workpiece on a single drawing (table drawing) is prohibited.
- 5) Drawings of individual parts/subassemblies are only to be created by the particular CATPart/subassembly (part/subassembly is opened in its own window), and not from the higher-level assembly.
- 6) The scale may **not** be used on the page of the drawing but has to be used on the individual drawing views.
- 7) The model geometry and the drawing geometry have to agree, i.e. there may not be any geometry changes made in the drawing or geometry generated.
- 8) Drill holes must always be measured using the drill hole itself and never by using axes and center lines.

- 9) Threaded inserts are identified with “Text with Reference Line”. Example: *Ensat M5* or *3x Ensat M5*
- 10) Locked view is **only permitted** in assembly drawings for section views.
- 11) The page background is space for administration. The user may not insert any elements here.
- 12) It is recommended that a drawing should be derived from the native subassemblies and not from the DMU assemblies. The reason is the greatly reduced functionality when deriving CGR data.

## 12 BA catalogs

### 12.1 Standard catalog



Specifications are saved in the BA standard catalog. The necessary comments on how to create drawings, PowerCopys, presentation of staff for ergonomic investigations and the current labeling (BA/HC) in various sizes can be found here.

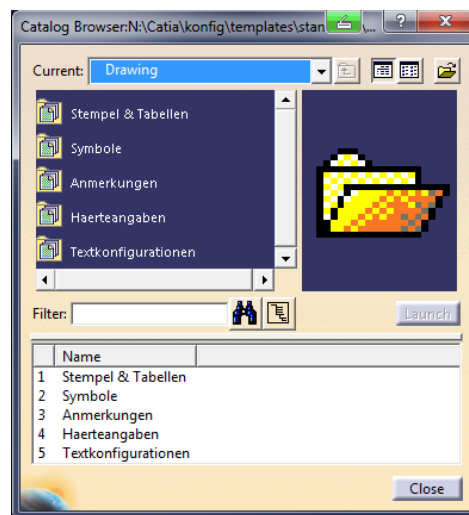

The following can be found in the catalogs:

#### OM design elements

- Cylindrical indentations
- Conical indentations
- Grooves for circlips
- Center holes
- Undercuts
- Semifinished goods
- Gearwheels
- Ensat bush
- Springs

#### OM drawing elements

- Stamp and tables
- Symbols
- Comments
- Hardness details
- Text configurations

#### OM standards

- Catalog parts
- Standard parts
- BA scraper blades

## 12.2 Material catalog



All workpieces from Broetje-Automation are saved in the BA\_workpiece catalog. The following separation was made:

- **Steel** - for use, see list of materials for heat treatment, steels for turned and milled parts
- **Steel** - preferred series for welded assemblies
- **Aluminum weldable** - for use, see material list
- **Aluminum machinable** - for use, see material list
- **Dimensions bought-in part** - material for manipulating the density of heterogeneous materials in bought-in parts
- **Bearing material**
- **Plastic**
- **Other** – only to be used in the draft phase if possible

Material can only be assigned to the part and not to the main body.

As the material has been exported from the EDM system to enter it in the title block, it is absolutely necessary that the user assigns a material from the material catalog to all the individual and welded parts. The macro “MaterialChange” is available for reconciling the material entry between the drawing and the model.

## 13 Handling standard and bought-in parts (internally)

### 13.1 Standard parts

Standard parts are created by detailing the standard and the dimensions of the TCE department and making them available via the catalog.

To do this, send an email to: [cad@broetje-automation.de](mailto:cad@broetje-automation.de)

### 13.2 Bought-in parts

Bought-in parts are created based on the following **handouts**:

- CAD Handout - Bought-in Part Generation
- EDM Handout - UseCase Bought-in Part Creation



## **14 Data quality**

Data is checked firstly project based (specific content and product structure based on the requirements of the project), and secondly based on general criteria (with the aid of the Q-checker).

Project-based test content has to be documented at the start of the project.

Following points have to be checked generally at the latest before data is released and rectified accordingly, if the test shows any faults (data that is created by external offices is returned for adjustment and not approved). BA can provide an internal checklist to external offices upon request.

- **CATDUA run must be logged.**
- **Assemblies must be updated.**
- **Assemblies must be positioned.**
- **There may not be any collisions.**
- **Controlling geometry has to be capable of functioning.**
- **Name based on specification**
- **Location based on specification**
- **Linking of data according to specifications**

## 15 External offices

External offices have to create and deliver CATIA models with the Broetje environment. To do this, Broetje Automation GmbH provides a CATIA environment that can be downloaded from an FTP server (access required).

You will receive access to the FTP server for the installation data from our CAD/EDM team. There you will find all the necessary documents for an installation and for carrying out the work, sample data, installation files, macros, the Broetje environment and the Broetje catalog.

The “*OM Hard-and Software Requirement*” and “*Installation Catia V5R18 with Airbus package and Broetje Environment*” documents are of importance for the administration and installation, the remaining documents for the design.

Bought-in parts can be taken from the Broetje catalog (n:/katalog/cdb/kaufteile/...). The designer has to model the bought-in parts that are not available in the Broetje catalog (after checking the FTP if the parts are now available) or buy them in from the manufacturer and are also saved in the working directory. Bought-in parts are produced in accordance with “**CAD Handout - Bought-in Part Generation**” that you will find on the FTP server.

Standard parts (screws, sticks, etc.) are created by our CAD/EDM team and made available via the catalog (n:/katalog/cdb/normteile/...). Should a standard part not be available in the catalog, please let the CAD/EDM team know by emailing details of the standard and external dimensions.

All referenced files are to be saved in the same directory, including bought-in parts and standard parts and sent.

The language tool with the related language database is included in the Broetje environment.

External offices are obliged to download the Broetje catalog and the language database each week from the FTP server and to save it on the directory N:\ or update it in the catalog directory.

You can turn to our CAD/EDM team in the event of queries:

Tel.: +49 4402 966460

[cad@broetje-automation.de](mailto:cad@broetje-automation.de)